

PR24 RAIL - DECKING

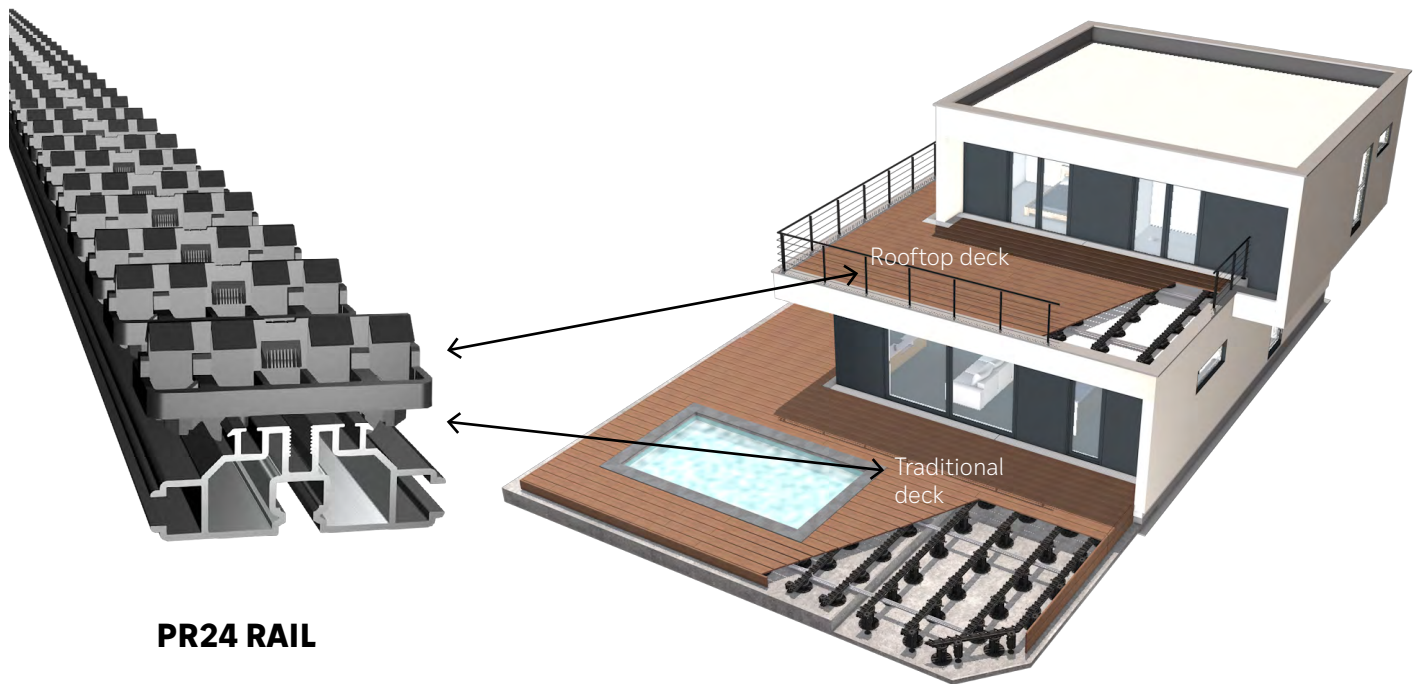

PR24 RAIL

PR24 RAIL DIMENSIONS - WITH CLIPS

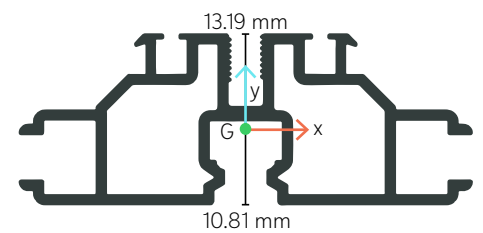
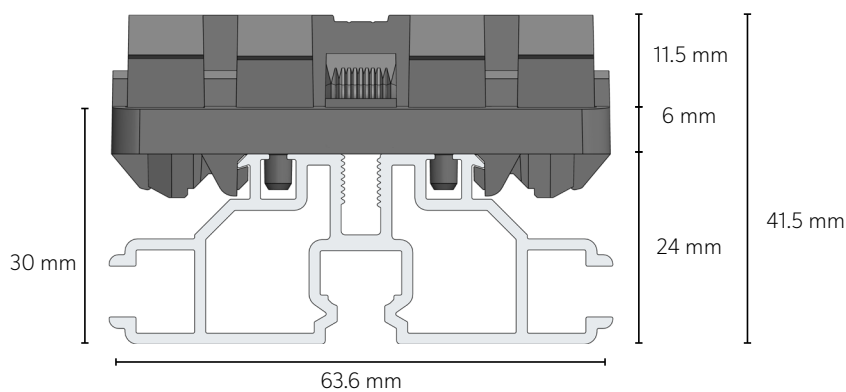

Position of center of gravity (G)

MOMENT OF INERTIA:

$$I_{xx} = 19602 \text{ mm}^4$$

$$I_{yy} = 87737 \text{ mm}^4$$

$$I_{xx/v} = 1486 \text{ mm}^3$$

ALUMINIUM RAIL

Material	Aluminium EN AW-6060
Mass per meter of rail without clips	0.878 kg
Colour	Black
Thermal Treatment	T6
Tensile strength (MPa)	190
Tensile stress at yield (MPa)	150
Minimal elongation (%)	6
Tensile modulus (MPa)	70000
Coefficient of linear expansion (10⁻⁶/K)	24
Fusion Temperature (°C)	585-655
Thermal conductivity (W/mK)	160



GRAD CLIP

Material	Polyoxymethylene
Density (kg/m³)	1410
Colour	Black
Tensile stress at yield (MPa)	64
Fusion temperature (°C)	190-220
Tensile modulus (MPa)	2850
Coefficient of linear expansion (10⁻⁶/K)	110

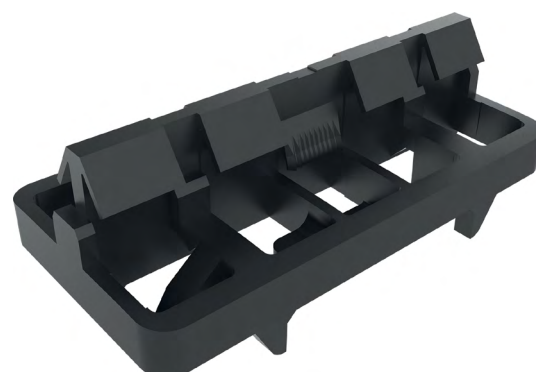

USE CATEGORIES ACCORDING TO FRENCH NORMS AND EUROCODE 1 EN 1991-1-1 FOR DECKING

Rail spans and pedestal spans are defined according to the distributed and concentrated loads, following French regulations and Eurocode 1 EN 1991-1-1, and not taking local requirements into account.

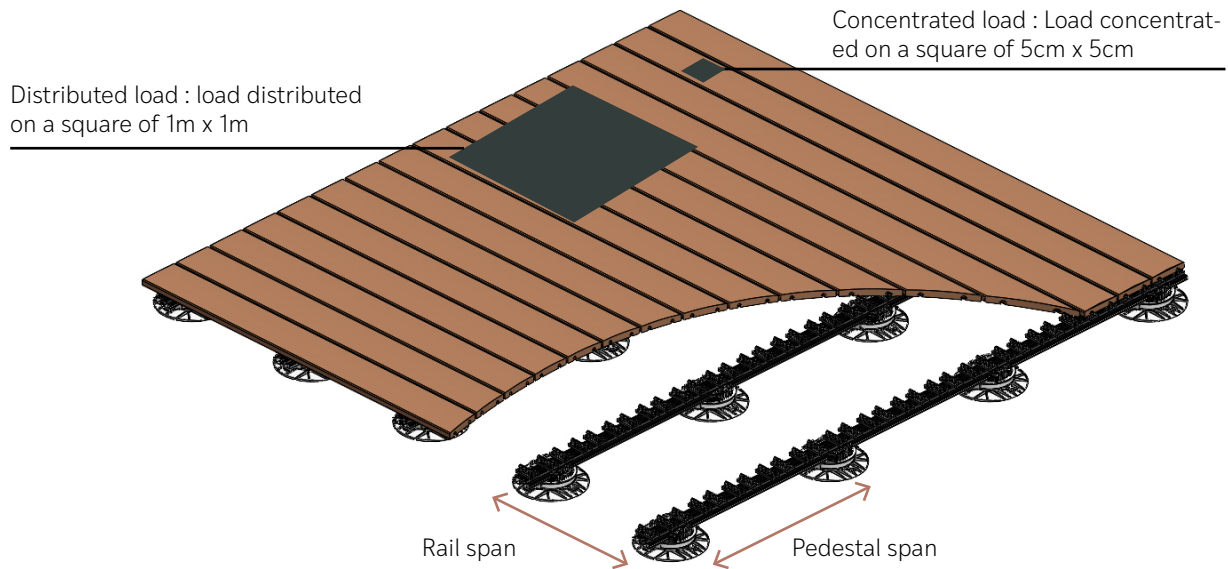

USE CATEGORY	SPECIFIC USE	DISTRIBUTED LOAD (kN/m ²)	CONCENTRATED LOAD (kN)
A	Residential: rooms in residential buildings and houses, hospital rooms and wards, hotel and hostel rooms, kitchens and sanitary facilities. Decks and balconies.	Floors	1.5
		Staircases	2.5
		Balconies	3.5*
B	Offices	2.5	4.0
C	C1 : Areas equipped with tables (schools, restaurants, reception halls, etc.)	2.5	3.0
	C2 : Spaces with fixed seating (theatre, cinema, conference room, etc.)	4.0	4.0
	C3 : Areas free of obstacles to human movement (museums, exhibition halls; access to administrative buildings, hotels, hospitals, stations, etc.)	4.0	4.0
	C4 : Spaces for physical activities (stage, dance hall, gym, etc.)	5.0	7.0
	C5 : Buildings intended for public events (concerts, sporting events including stands, terraces and access areas; station platforms, etc.)	5.0	4.5
D	D1 : Standard retail	5.0	5.0
	D2 : Department stores	5.0	7.0

* Maximum load for use category A

DECKING RAIL SPACING

CALCULATION ASSUMPTIONS

The calculation approach used is that defined using French norms:

- NF DTU 51.4 - deck ≤ 1 m from the ground for decks with 3 or more supports.
- Les Règles Professionnelles de la CSFE (Chambre Syndical Française d'Étanchéité) - design and construction of waterproofed flat roofs and balconies for decks with 2 supports.

DECK WITH 2 SUPPORTS

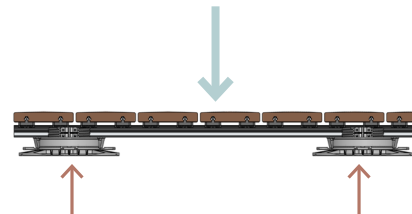
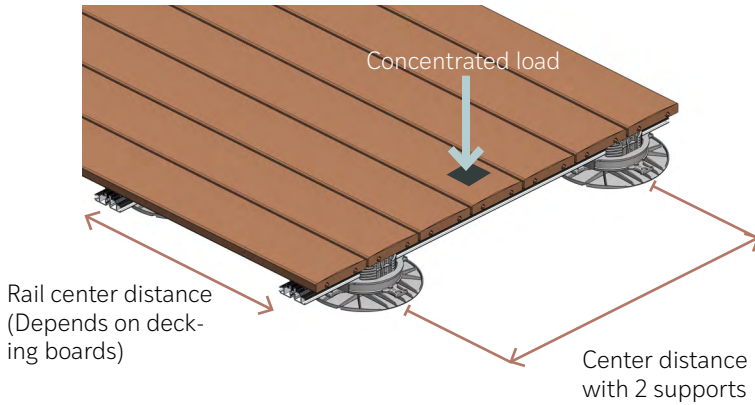

DECK WITH 3 OR MORE SUPPORTS

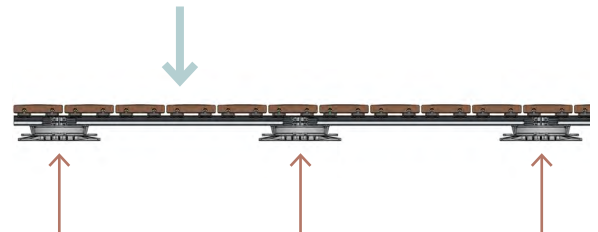
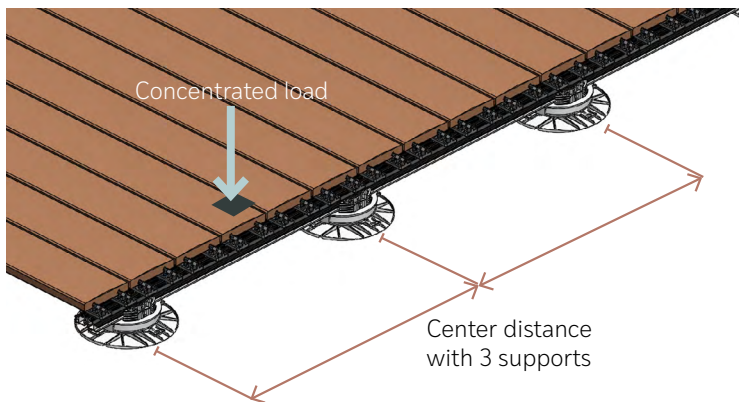

Distributed load : load distributed on a square of 1m x 1m

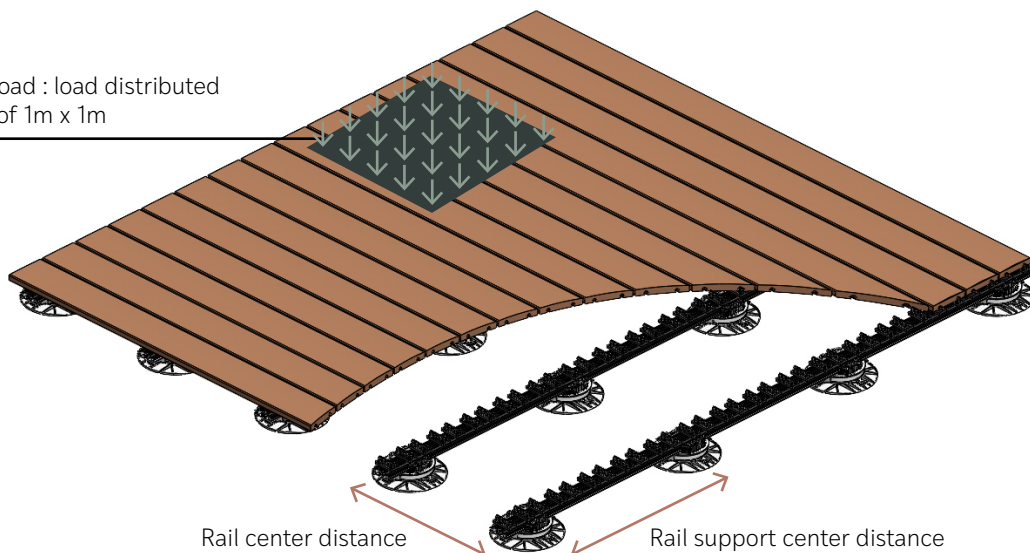

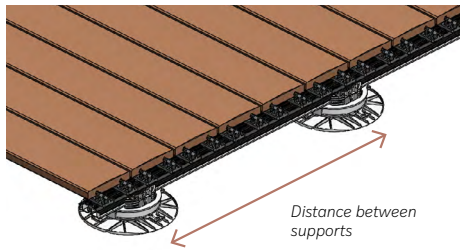
RAIL SPACING IN MM ACCORDING TO FCBA (lead organisation group in France) CALCULATIONS (CALCULATED VALUES)

The maximum center-to-center distances of the rail supports comply with the deflection and load constraints of the usage categories.

The values given below for rail spacing do not take into account local regulations.

Use category	A	B	C1	C2/3	C4/D2	C5	D1
3 supports as per French norms for rail spacing from 350 to 600 mm	380	240	310	240	n/a	220	n/a
2 supports as per French norms for rail spacing from 350 to 600 mm	292	n/a	238	n/a	n/a	n/a	n/a

SNOW LOADS ACCORDING TO FRENCH NORMS AND EUROCODE 1 EN 1991-1-3 FOR DECKING

The centre distances in the table above apply to the following snow conditions:

REGIONS	A1	A2	B1	B2	C1	C2	D	E
Characteristic value (S_k in kN/m^2) of the snow load on the ground at an altitude below 200 m	0.45	0.45	0.55	0.55	0.65	0.65	0.9	1.4
Calcul value ($S_{k,d}$ in kN/m^2) of the exceptional snow load on the ground	0.45	1	1	1.35	0.65	1.35	1.8	1.4

WIND SPEED CHARACTERISTICS

Wind speed $V_{b,0}$ (m/s)	17	22	24	26	28	30	32	34	36
Maximum characteristic lift $W_{k,max}$ (kN/m^2)	-0.56	-0.94	-1.11	-1.31	-1.51	-1.74	-1.98	-2.23	-2.50

Grad can carry out a study of the number of required ground anchor points if justification is required from an inspection authority.

TECHNICAL SOLUTIONS FOR ANCHORING THE DECK TO THE GROUND IN RELATION TO WIND UPLIFT STRESS

The deck can be anchored to the ground on a hard surface such as a concrete slab. For waterproofed terraces, vertical threaded rods can be installed by the waterproofing contractor. The waterproofing company will seal the rod around the membrane.

FLOOR MOUNTING

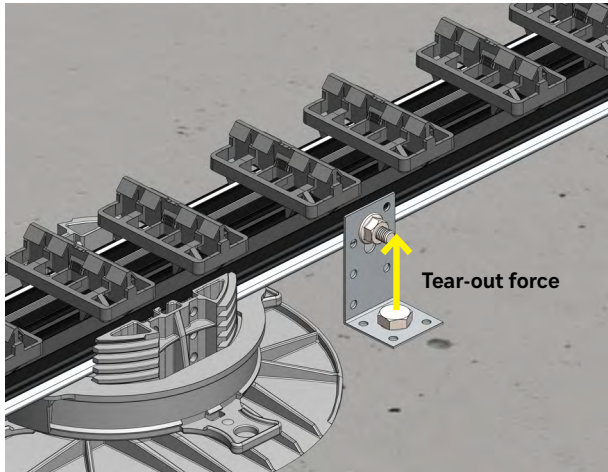

Use an angle bracket or steel strip with M6 bolts to anchor the deck to the ground. Fastening is staggered, and the number of anchors per m² can be determined by taking into account the uplift force due to wind and the deck's own weight.

The M6 bolts can be slid along the lateral grooves of the PR24 rails.

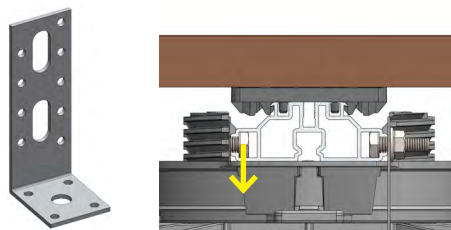

The characteristic strength of the bolt in the rail is:
Fax,Rd = 3383 N

WALL MOUNTING

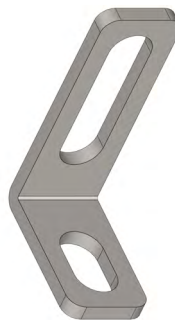
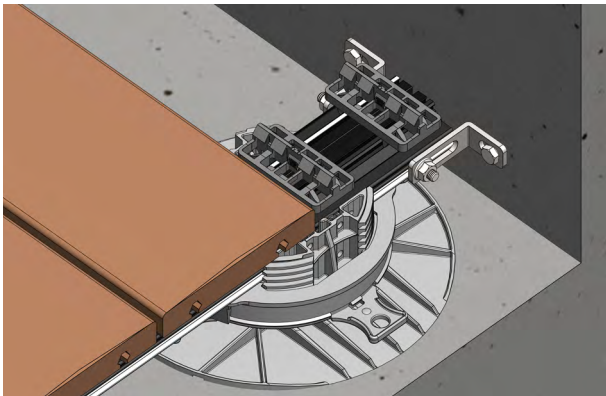

A wall-mounting solution is also possible, using the same principle as above, with a bracket on each side of the rail.

Grad brackets (ref. 70372, screws not supplied) are ideal for this purpose.

Caution: Any intervention on the wall may result in the loss of the ten-year warranty.

Other anchoring possibilities are also possible, thanks to the rail's multiple grooves.

COMPATIBLE SCREWS FOR ANCHORING VIA RAIL GROOVES

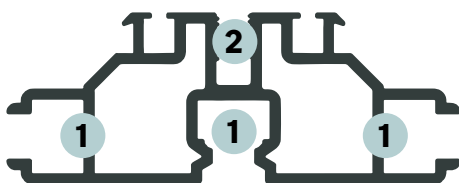

1 M6 hex head screw or nut

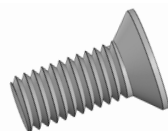

2 M5 countersunk screw